

A-A (1 : 15)

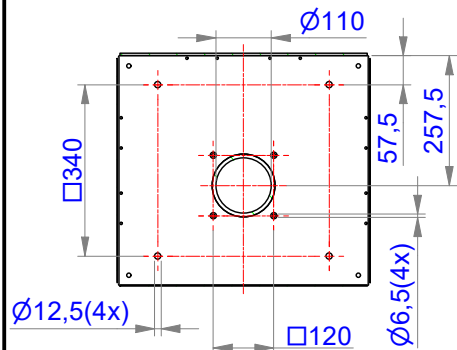

AM.PROJECTIE	SCHAAL: 1 : 28	GET: Jonker	MAT:
	DATUM: 5-1-2023	PROJECT:	OPMERKING:
	MAATEENH: MM	TOL. (tenzij anders vermeld): ± 0.5	
Ferlin		FGB 10-7	
Galileistraat 29 7701 SK Dedemsvaart Info@ferlin.nl		A4	TEK.NR.: FGB 10-7
ALL RIGHTS RESERVED FERLIN TRADING B.V.		BLAD: 1 VAN 1	REVISIE: 5-1-2023